



SMIM-700 ICE MACHINE

INCLUDE 2 YEAR PARTS + LABOR / 5 YEAR COMPRESSOR WARRANTY

Dimensions

Overall Dimensions (WxDxH)	30" x 32.6" x 67.6"
Machine Dimensions (WxDxH)	30" x 24.3" x 22.4"
Bin Dimensions (WxDxH)	30" x 32.7" x 45.3"
Output (lb/24hr)	700 lbs
Bin Capacity	375 lbs
Net Weight (Machine)	150 lbs
Gross Weight (Machine)	159 lbs
Net Weight (Bin)	100 lbs
Gross Weight (Bin)	111 lbs
Packaging Dimensions (Main Machine) (WxDxH)	33.2" x 29.5" x 24.4"
Packaging Dimensions (Ice Bin) (WxDxH)	33.4" x 35" x 41.5"
Ice Cube Size half cube	.86" x .86" x .86"

Construction

Exterior Material	304 stainless steel
Interior Material	Polyethylene
Water Filter Capacity	2.2 GPM
UV Light Included For Sanitation	

Cooling

Refrigerant	R290
Temperature Display	Yes
Temperature Controller	Digital
Condenser Unit	Air
Compressor	Secop

Electrical

Voltage	220V
Power	1680W
Hz	60

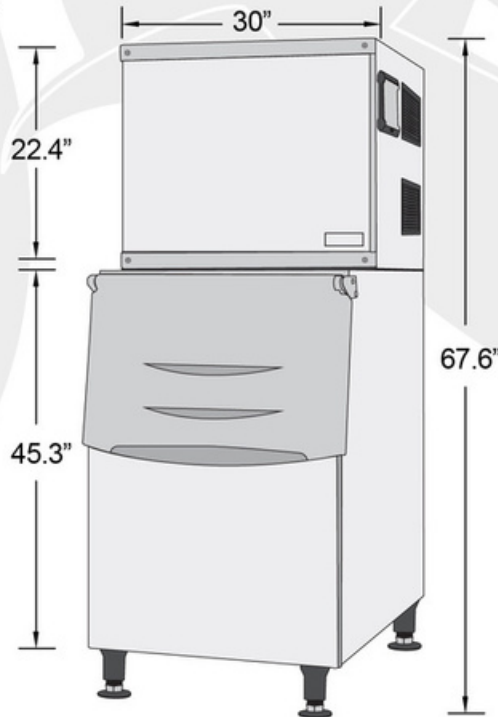

3/4 View



Intertek

COMPLIES WITH ANSI/NSF 7
FOR FOOD SERVICE

6-20 Plug