



## ACB-60 2 DRAW CHEF BASE

INCLUDE 3 YEAR PARTS + LABOR / 5 YEAR COMPRESSOR WARRANTY

### Dimensions

Exterior Dimensions (WxDxH)	60" x 31.02" x 25.51"
Interior Dimensions (WxDxH)	
Capacity (cu. ft.)	9.8 cu. ft.
Weight	231 lbs
Packaging Dimensions (WxDxH)	

### Construction

Exterior Material	Stainless 430
Interior Material	Stainless 443CT or 445NF
Insulation Material	Cyclopentane
Shelf Material	
Shelf Load Capacity	
# Shelves	2

### Cooling

Temperature Range	32° - 41° F
Refrigerant	R290
Maximum Ambient	100° F
Temperature Rating	N Class
Defrosting	Automatic
Temperature Display	Digital Thermometer
Temperature Controller	Thermostat
H/P	1/4

### Electrical

Voltage	115
Amps	3.0A
Hz	60
Phase	1

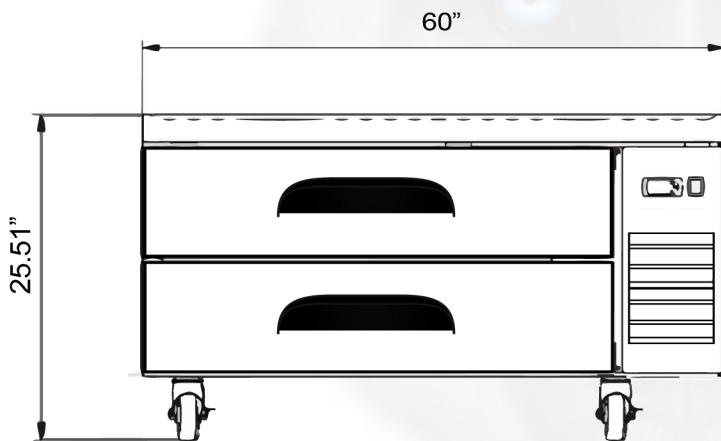

Front View

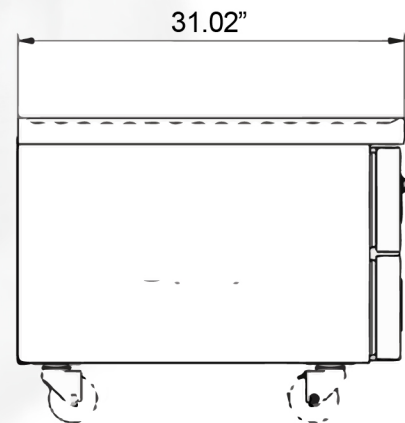

Side View



Intertek