



ACB-48 2 DRAW CHEF BASE

INCLUDE 3 YEAR PARTS + LABOR / 5 YEAR COMPRESSOR WARRANTY

Dimensions

Exterior Dimensions (WxDxH)	48" x 31.02" x 25.51"
Interior Dimensions (WxDxH)	
Capacity (cu. ft.)	8.6 cu. ft.
Weight	207 lbs
Packaging Dimensions (WxDxH)	

Construction

Exterior Material	Stainless 430
Interior Material	Stainless 443CT or 445NF
Insulation Material	Cyclopentane
Shelf Material	
Shelf Load Capacity	
# Shelves	2

Cooling

Temperature Range	32° - 41° F
Refrigerant	R290
Maximum Ambient	100° F
Temperature Rating	N Class
Defrosting	Automatic
Temperature Display	Digital Thermometer
Temperature Controller	Thermostat
H/P	1/4

Electrical

Voltage	115
Amps	3.0A
Hz	60
Phase	1

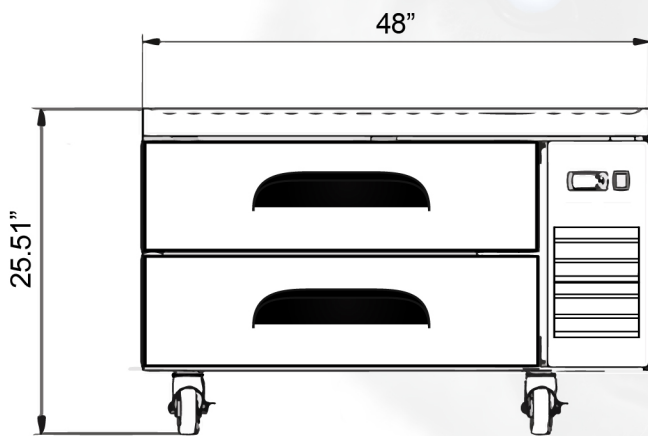

Front View

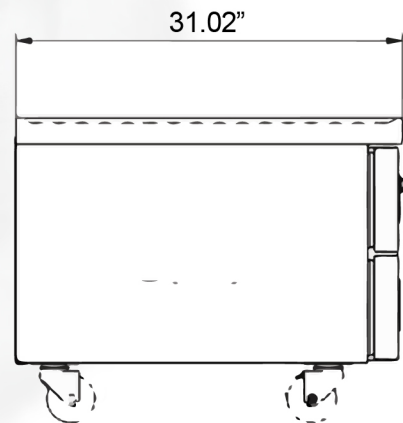

Side View



NEMA 5-15P



Intertek

